

DP		3.5
Number of teeth	Z	103
Addendum modification	x	0
Pressure angle	a	20°
Accuracy grade		10-ISO 1328/97

gear precision

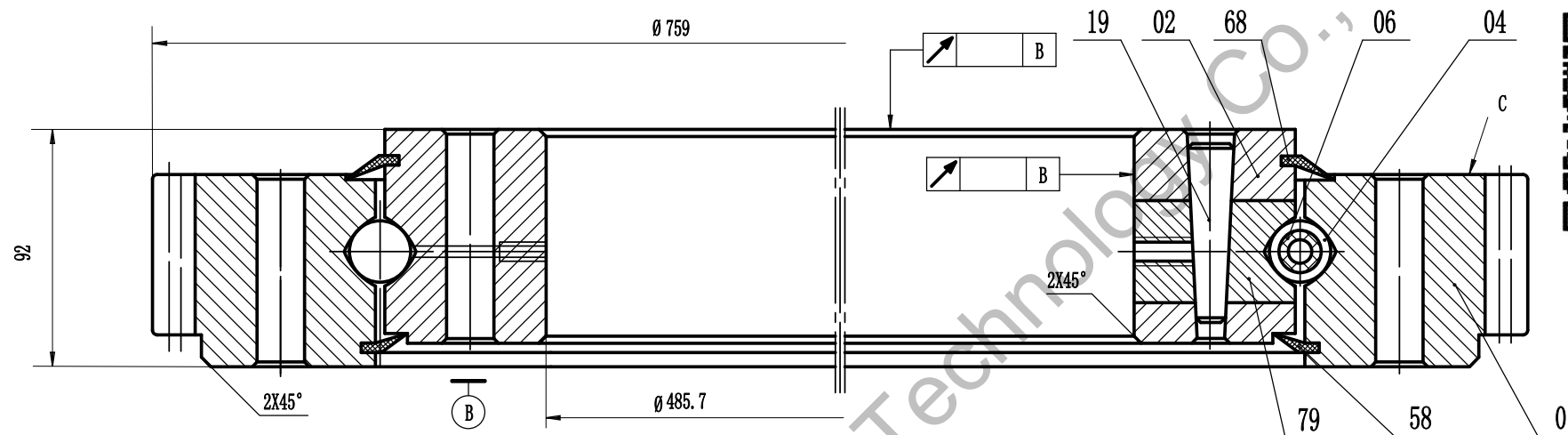

Remark:

1. Luoyang JCB Bearing Technology Co., Ltd is a technical Inc, specialize in designing and manufacturing slewing ring bearing, we can design and manufactur all kinds of slewing bearing according to client's requirement.
2. This drawing is reference for user, if you need formal drawing, please contact wth us sales@jcb-bearing.com, the official drawing will be submitted after order confirmation.

Contact information

Company Address : No.3 Lianmeng road, Luoyang, Henan, China.
 Postal code : 471003
 Phone : 86-379-68611678 Fax : 86-379-68611679
 E-mail: sales@jcb-bearing.com
 Reserved E-mail: sales@slewing-ring-bearings.com
 Website: www.jcb-bearing.com
 www.slewing-ring-bearings.com

58	second seal	1	oil resistant rubber			
68	seal	1	oil resistant rubber			
79	plug	1	steel			
19	taper pin	1	steel			
06	cage		nylon			
04	steel ball		steel			
02	inner ring	1	steel			
01	outer ring	1	steel			
No.	name	qty	material	unit	total	
				weight	(kg)	
						9E-1B45-0609-0651
						weight(kg)
			four-point contact ball slewing ring bearing		148	
				total page	8	page No. 1
				Luoyang JCB Bearing Technology Co., Ltd		